



THUNDURUS

by Brandon

Build by Olber

Paper Pokés
www.pokemonpapercraft.net

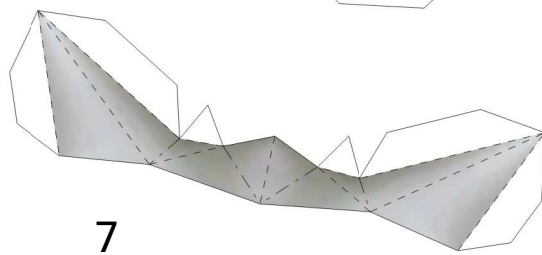
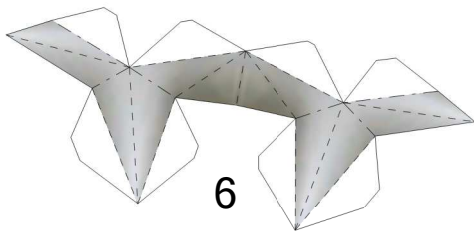
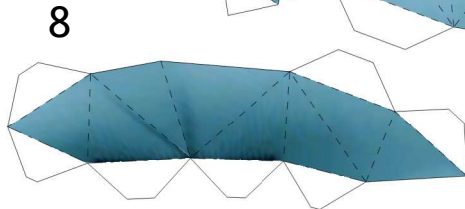
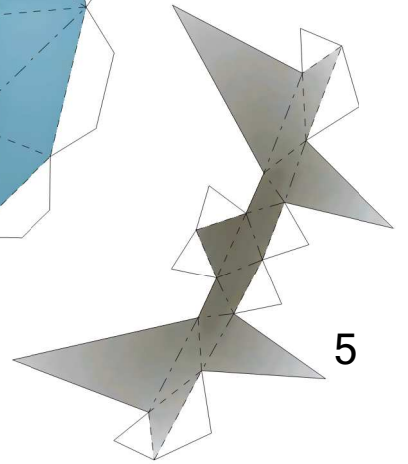
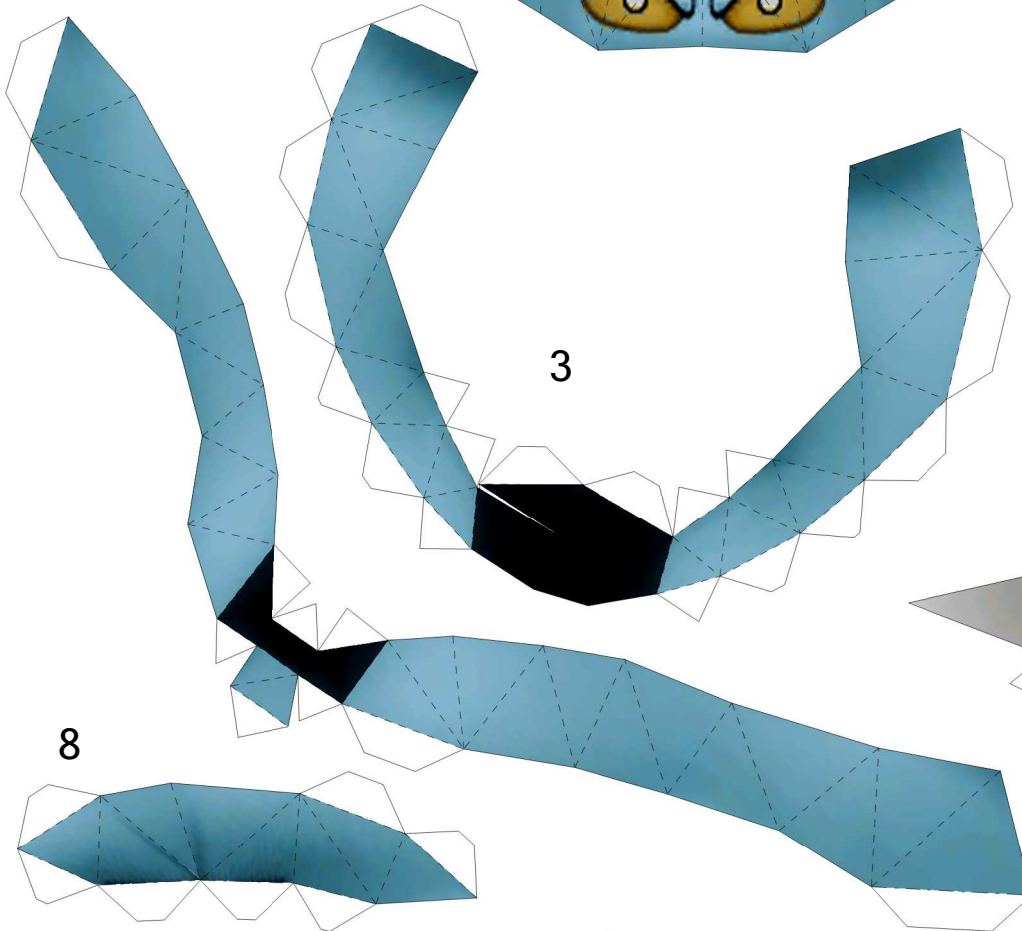
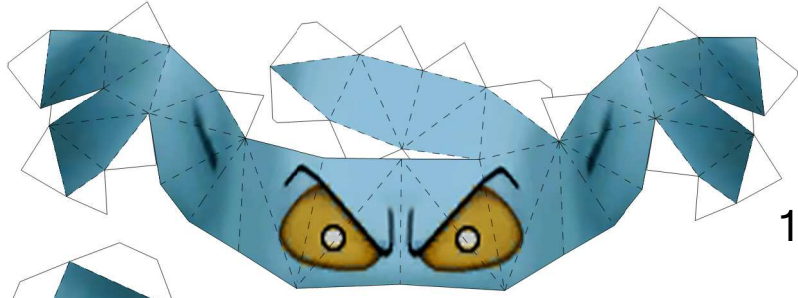
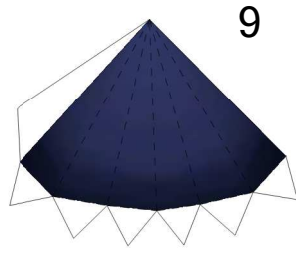
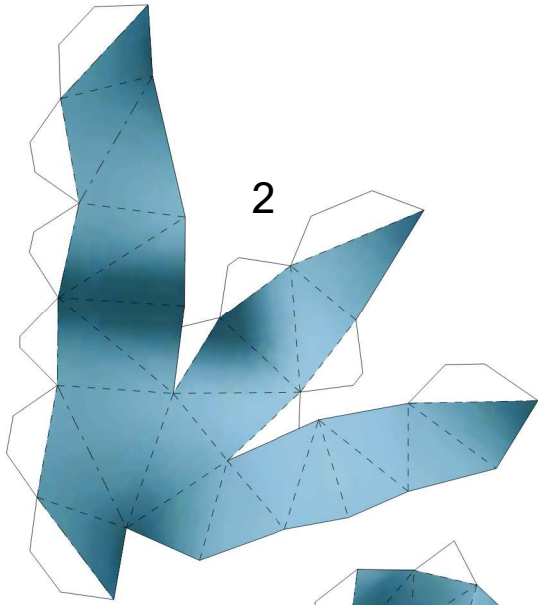

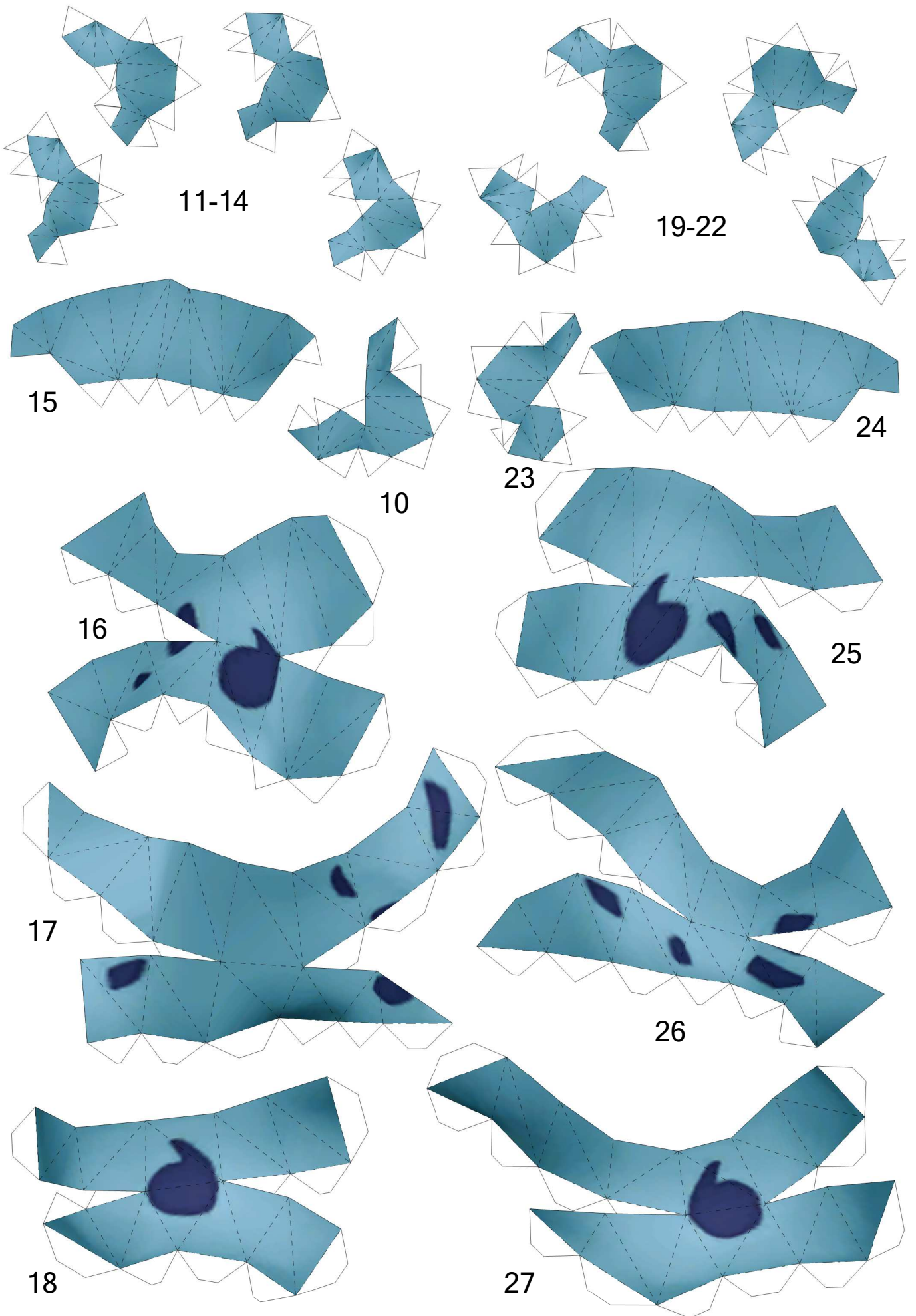

7

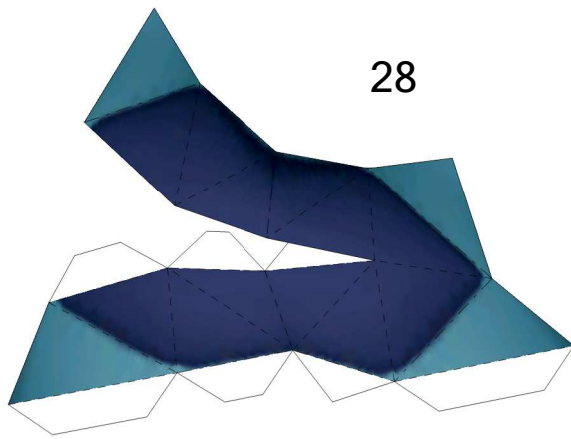

28

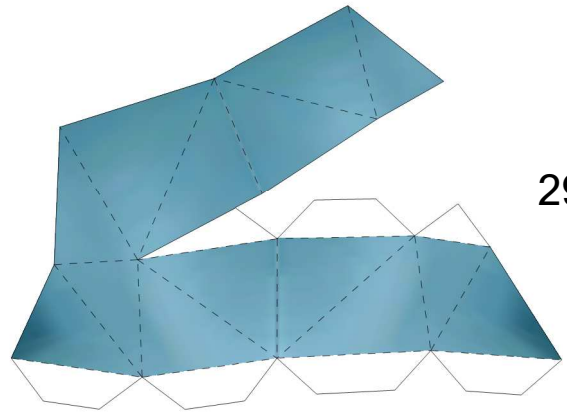

29

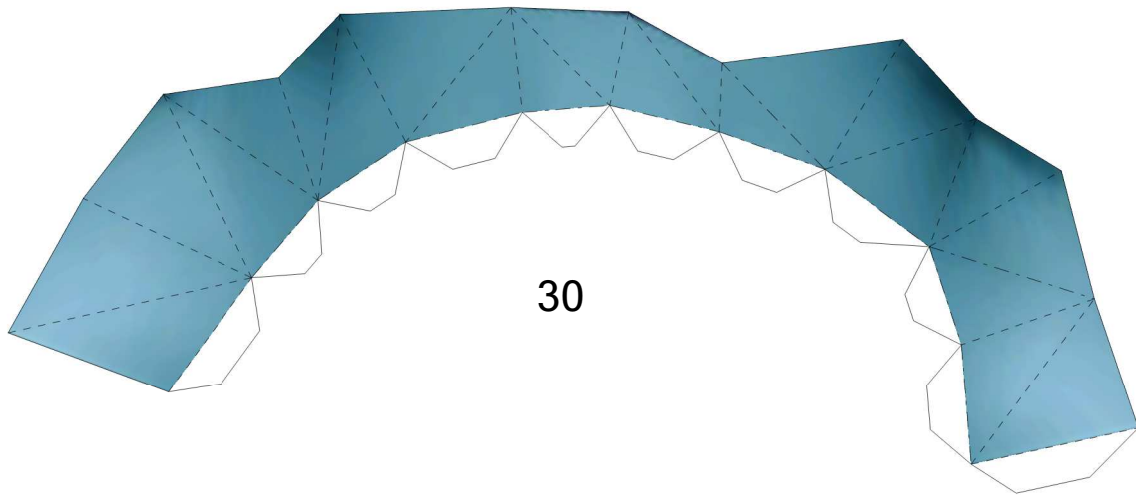

30

Build from top to bottom. Do the Cloudy- Hair first.
Then go your way down. Be patient with fingers.
Build the Cloud base from bottom to top.
Stick the tail when you're done.
Have fun

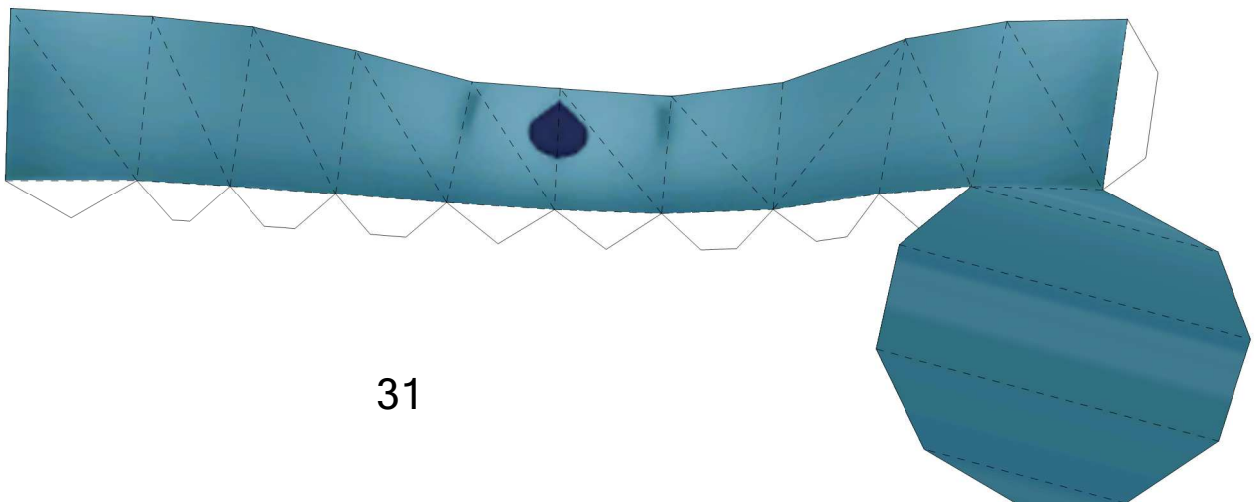

31

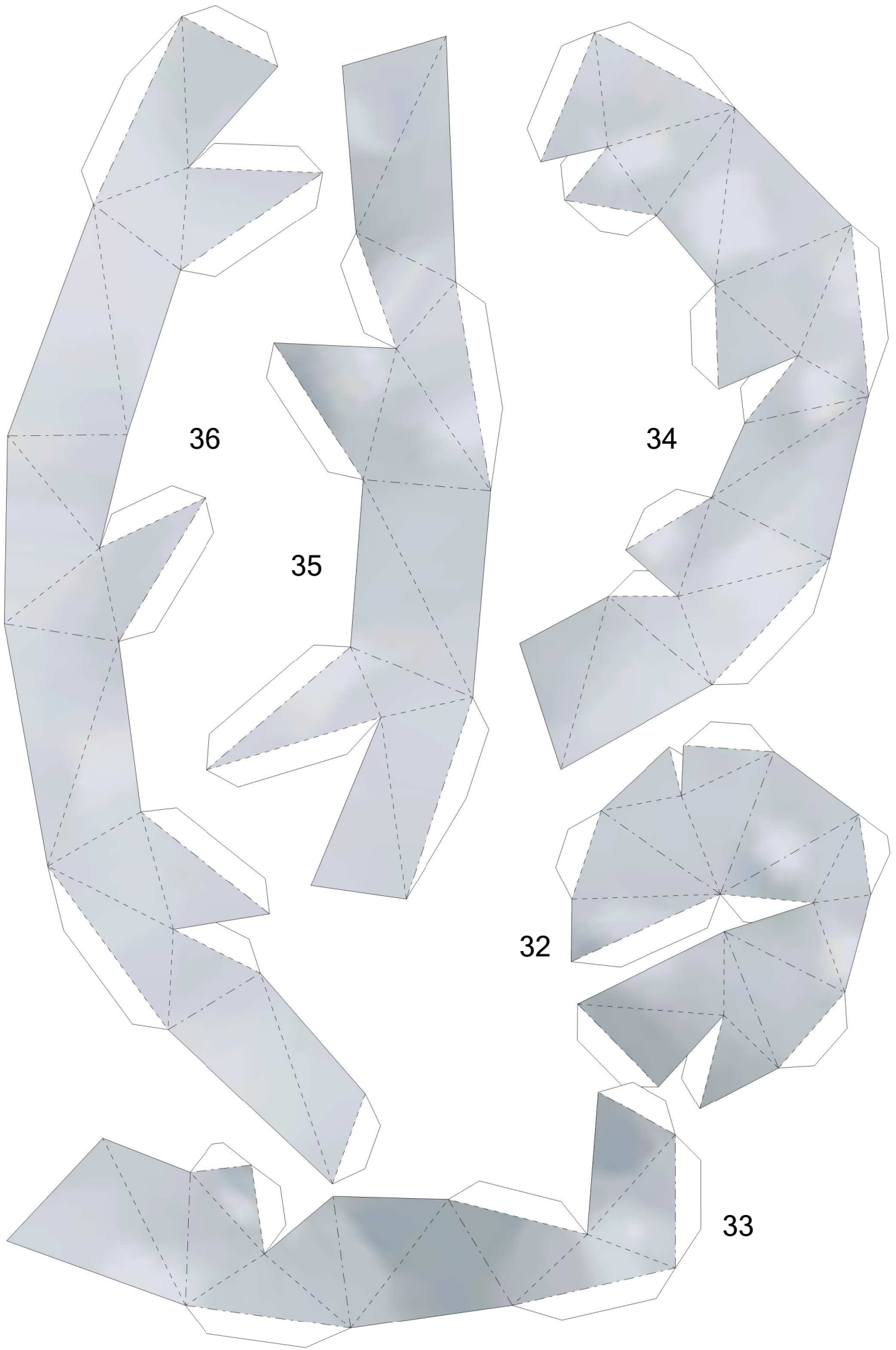

36

34

35

32

33

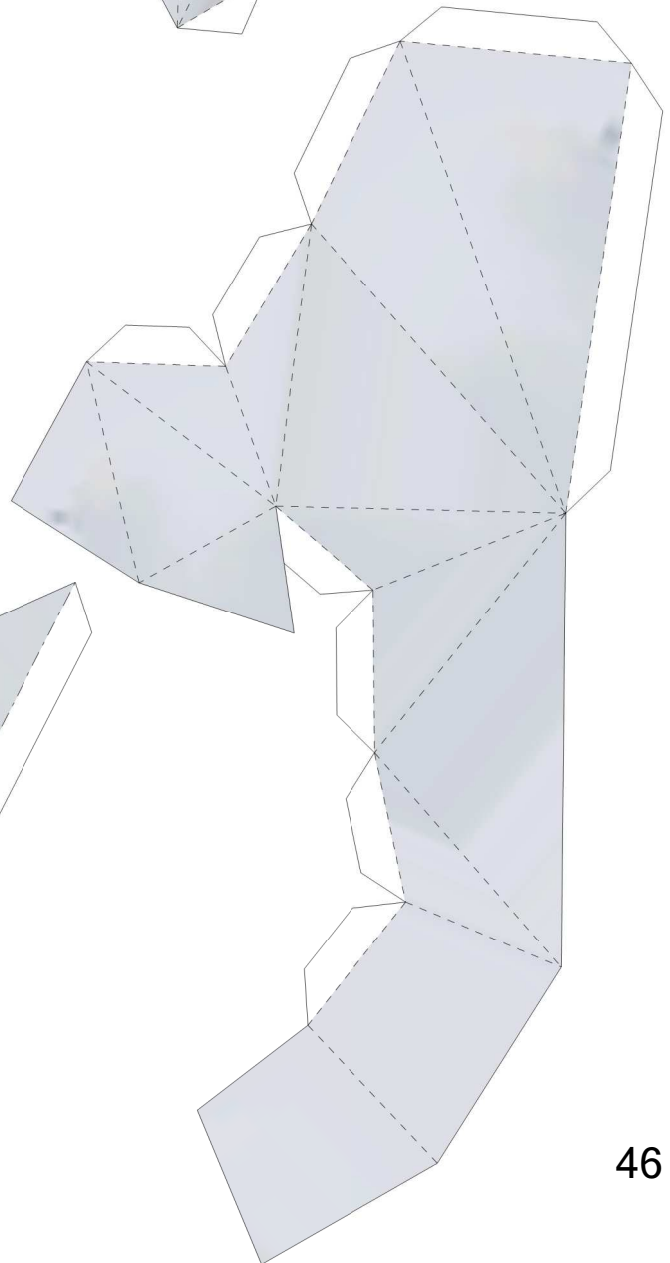
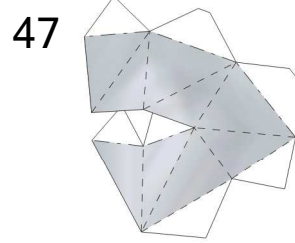
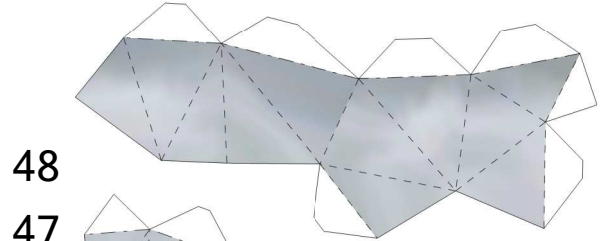
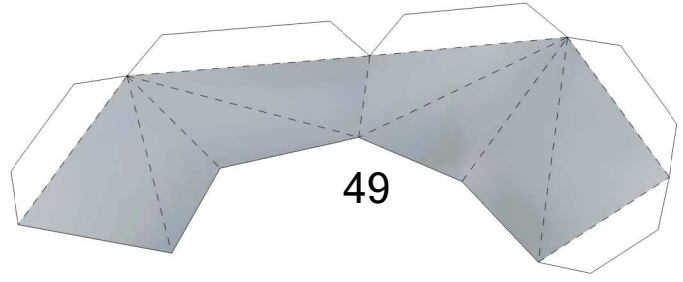
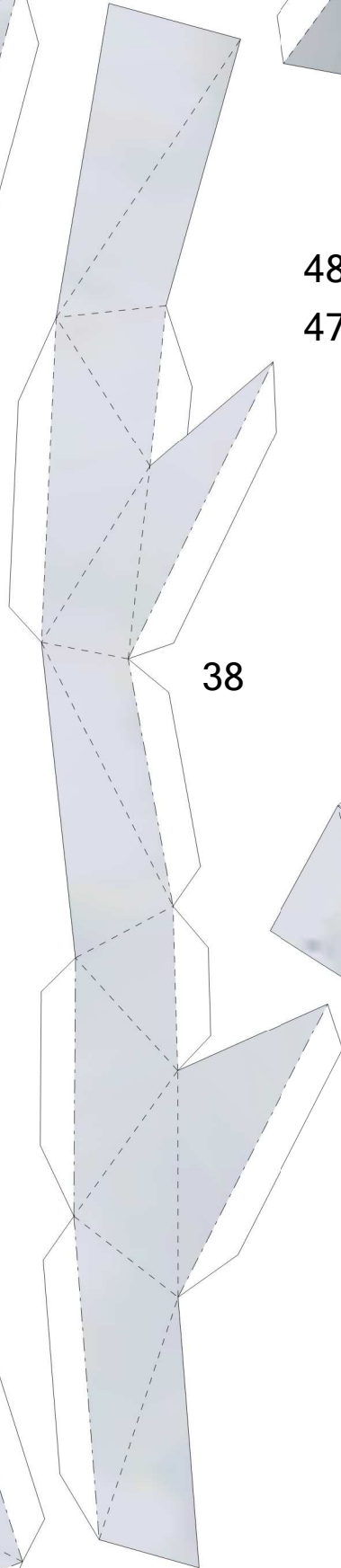
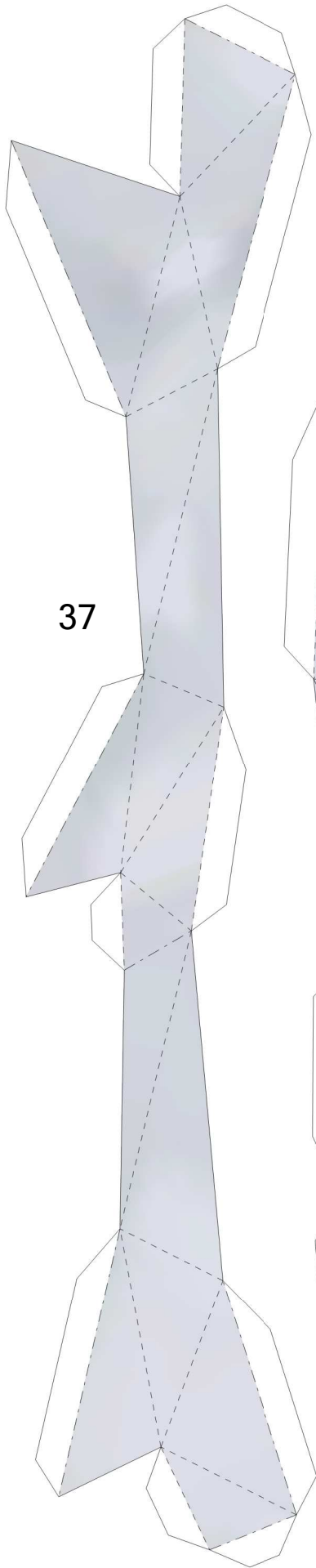

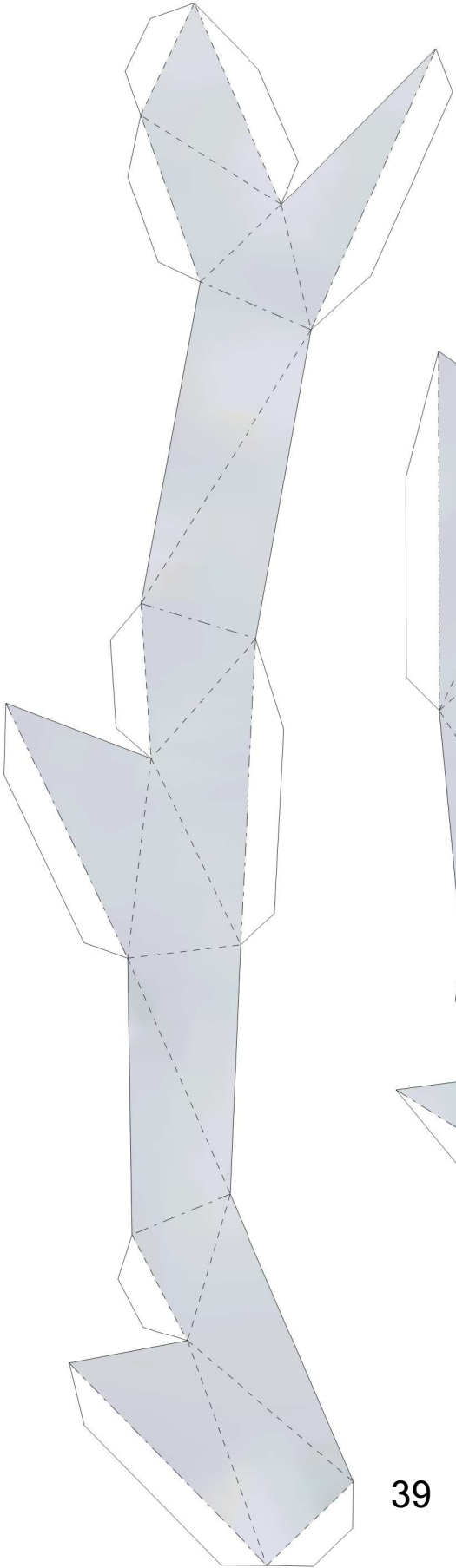

39

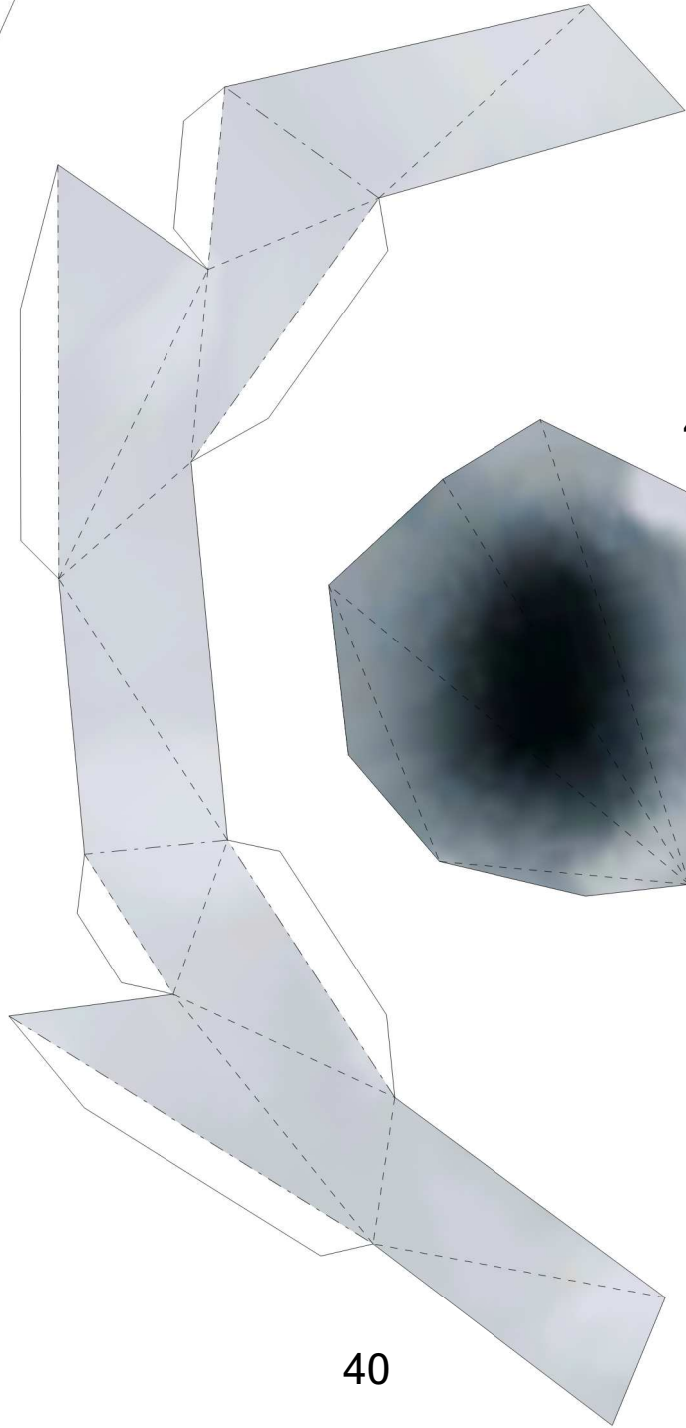

40

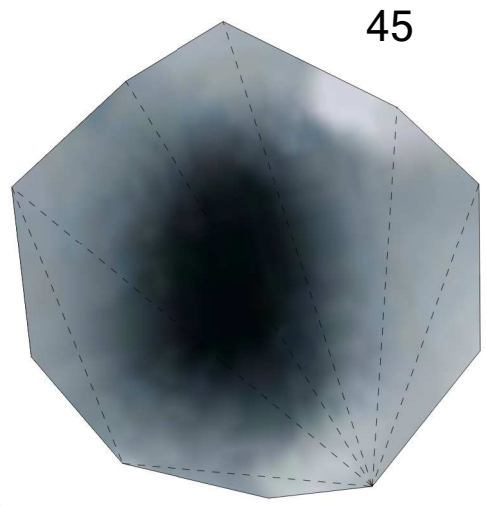

45

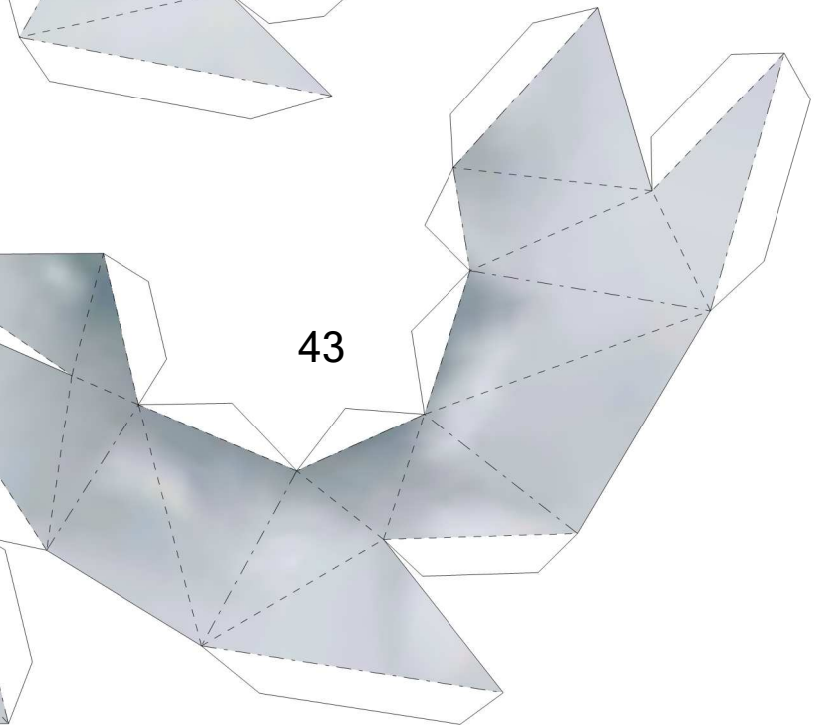
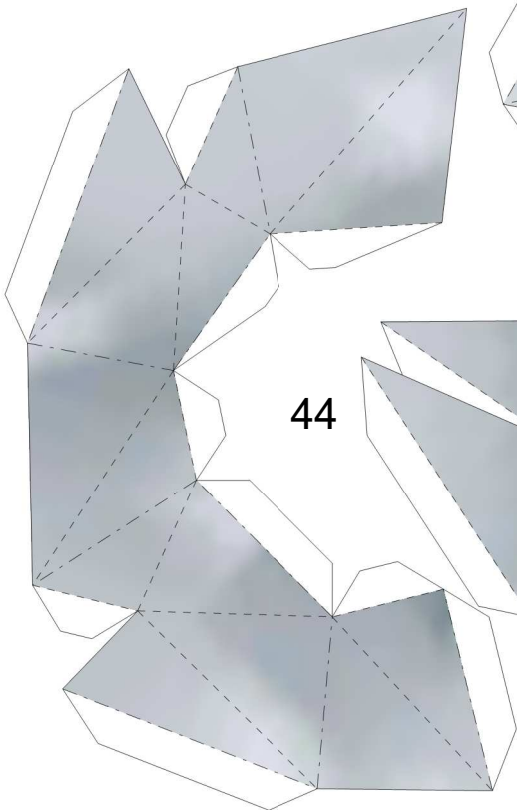
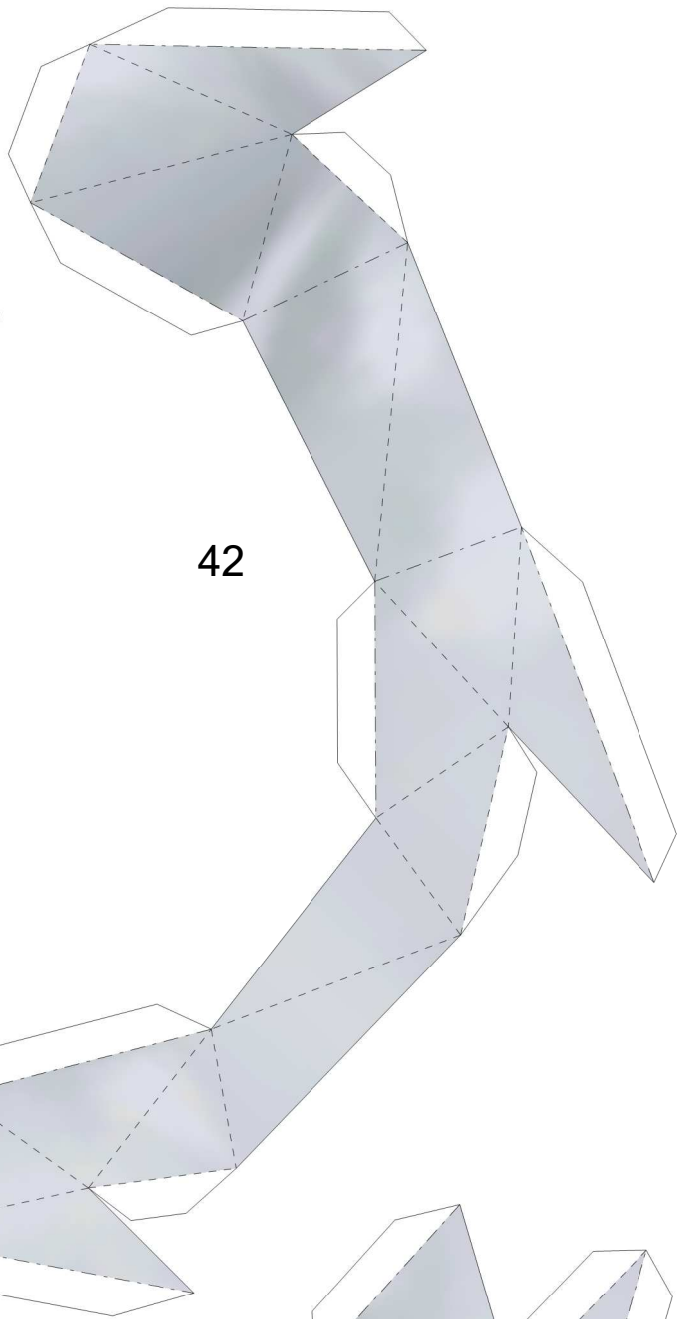
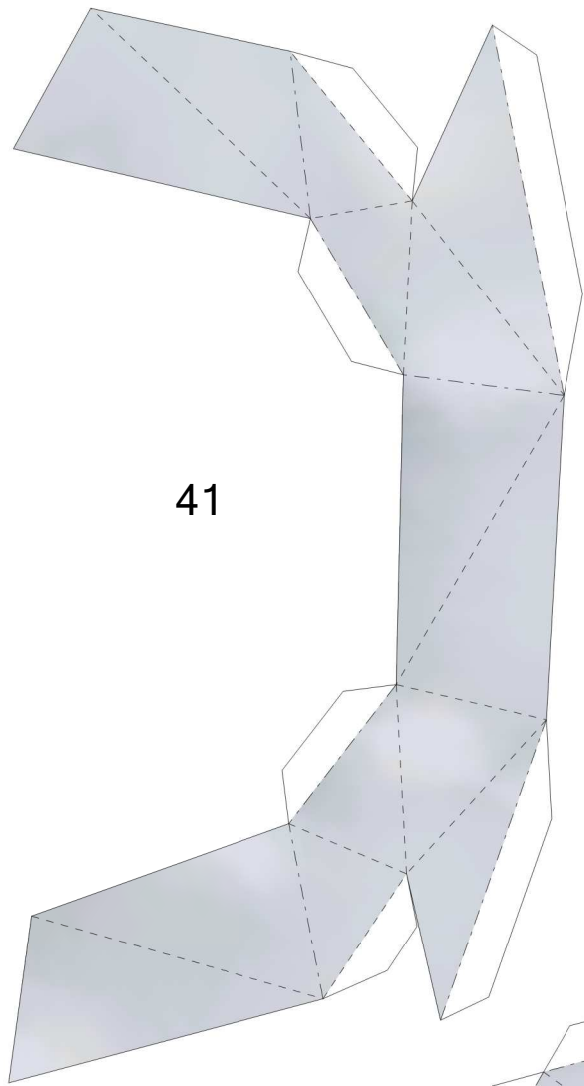

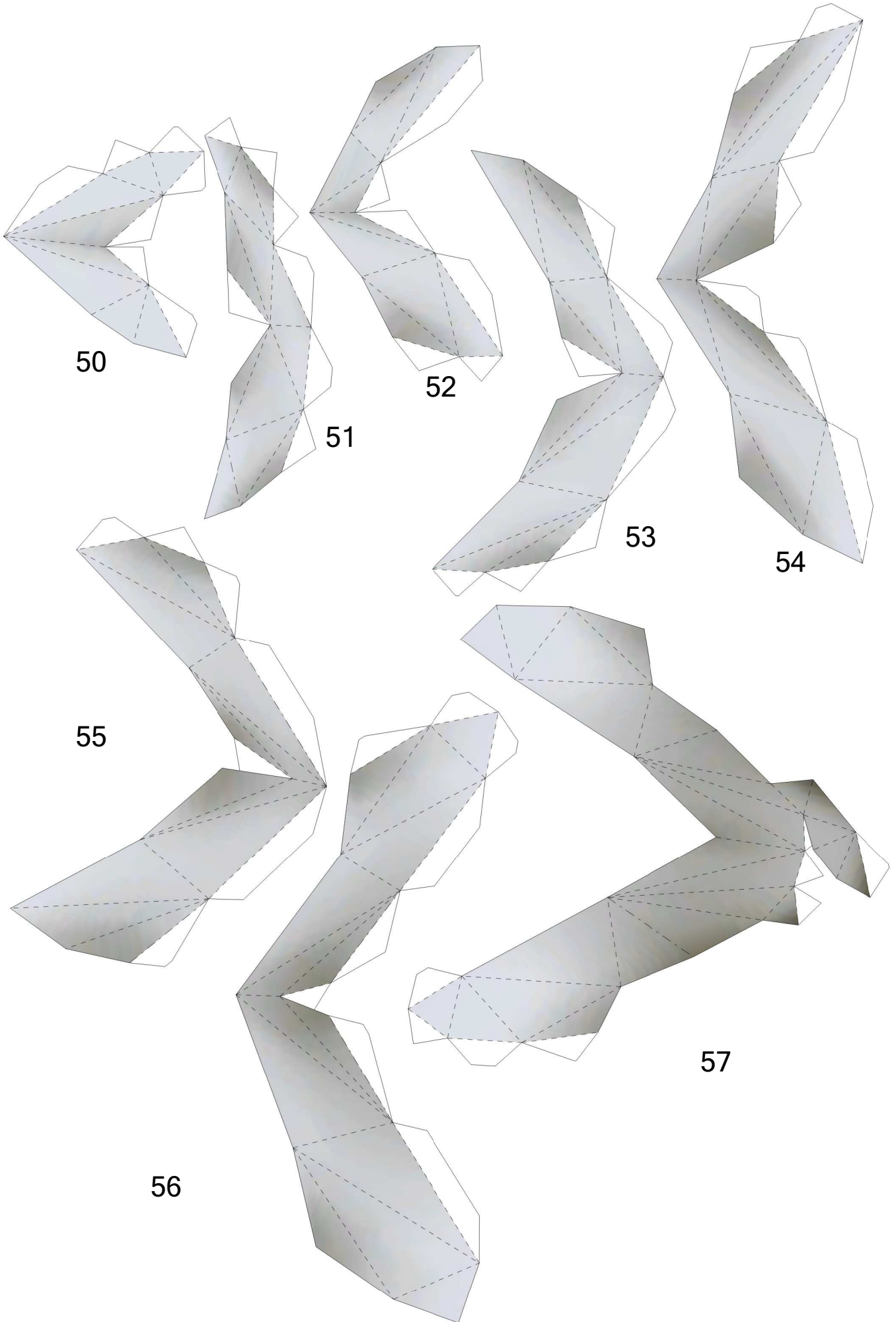

50

52

51

53

54

55

56

57

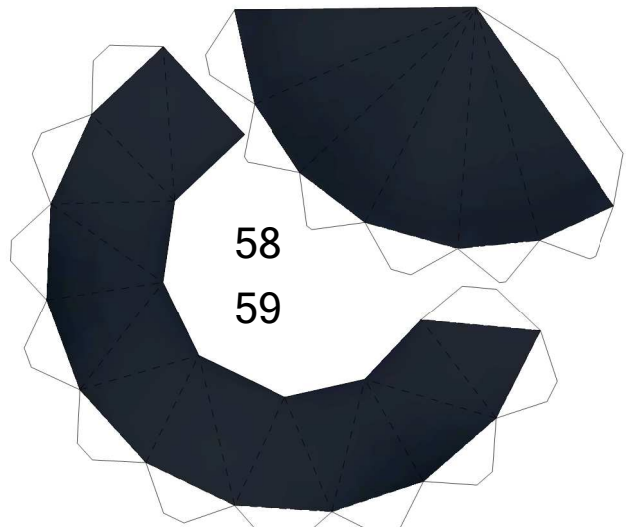

58
59

61
60

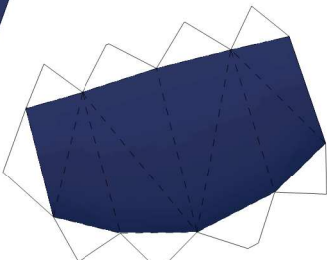
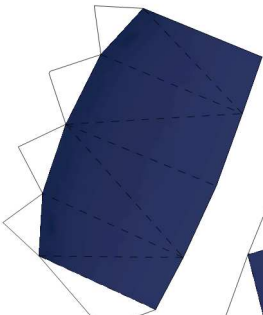
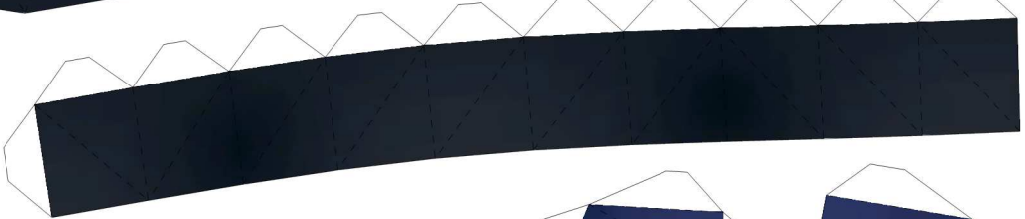

62 63

64

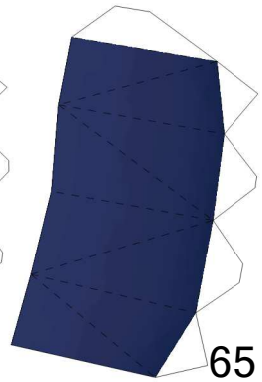

65

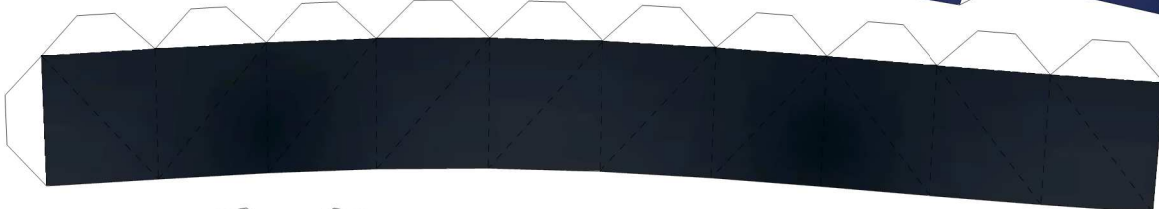

68
69

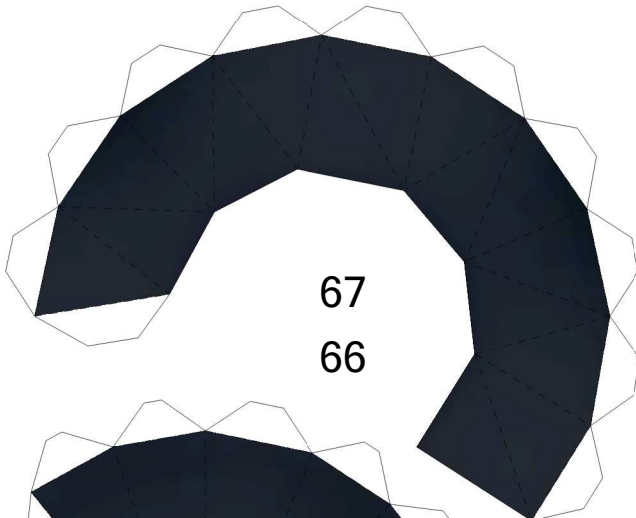

67
66



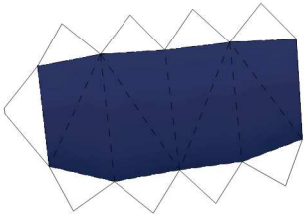
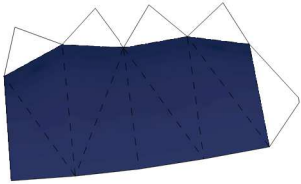
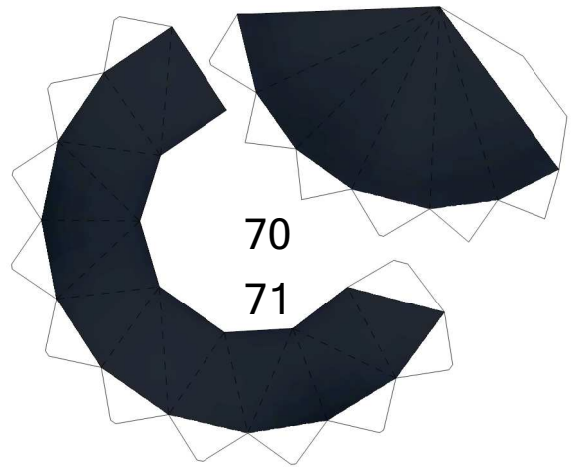
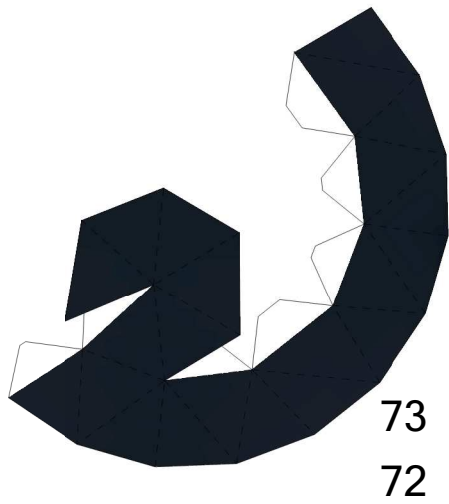

74
75

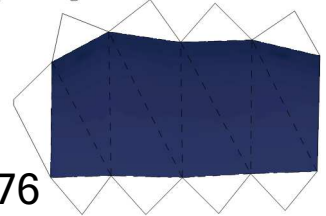

76
77

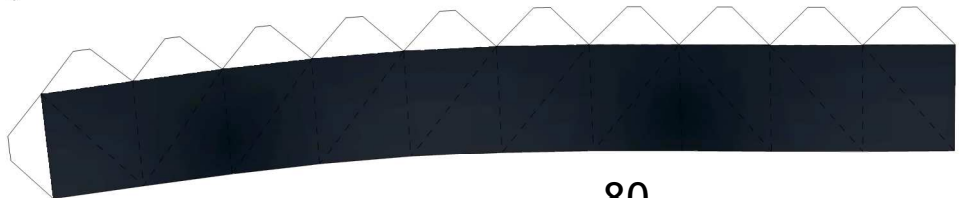
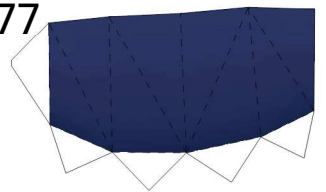

80
81

